



Standard Guide for Evaluating Data Acquisition Systems Used in Cyclic Fatigue and Fracture Mechanics Testing¹

This standard is issued under the fixed designation E 1942; the number immediately following the designation indicates the year of original adoption or, in the case of revision, the year of last revision. A number in parentheses indicates the year of last reapproval. A superscript epsilon (ϵ) indicates an editorial change since the last revision or reapproval.

1. Scope

1.1 This guide covers how to understand and minimize the errors associated with data acquisition in fatigue and fracture mechanics testing equipment. This guide is not intended to be used instead of certified traceable calibration or verification of data acquisition systems when such certification is required. It does not cover static load verification, for which the user is referred to the current revision of Practices E 4, or static extensometer verification, for which the user is referred to the current revision of Practice E 83. The user is also referred to Practice E 467.

1.2 The output of the fatigue and fracture mechanics data acquisition systems described in this guide is essentially a stream of digital data. Such digital data may be considered to be divided into two types—Basic Data, which are a sequence of digital samples of an equivalent analog waveform representing the output of transducers connected to the specimen under test, and Derived Data, which are digital values obtained from the Basic Data by application of appropriate computational algorithms. The purpose of this guide is to provide methods that give confidence that such Basic and Derived Data describe the properties of the material adequately. It does this by setting minimum or maximum targets for key system parameters, suggesting how to measure these parameters if their actual values are not known.

2. Referenced Documents

2.1 ASTM Standards:²

- E 4 Practices for Force Verification of Testing Machines
- E 83 Practice for Verification and Classification of Extensometer

¹ This guide is under the jurisdiction of ASTM Committee E08 on Fatigue and Fracture and is the direct responsibility of Subcommittee E08.03 on Advanced Apparatus and Techniques.

Current edition approved May 1, 2004. Published June 2004. Originally approved in 1998. Last previous edition approved in 1998 as E 1942 - 98 ϵ ¹.

² For referenced ASTM standards, visit the ASTM website, www.astm.org, or contact ASTM Customer Service at service@astm.org. For *Annual Book of ASTM Standards* volume information, refer to the standard's Document Summary page on the ASTM website.

- E 467 Practice for Verification of Constant Amplitude Dynamic Forces in an Axial Fatigue Testing System
- E 1823 Terminology Relating to Fatigue and Fracture Testing

3. Terminology

3.1 Definitions:

3.1.1 *bandwidth* [T^1]*—*the frequency at which the amplitude response of the channel has fallen to $1/\sqrt{2}$ of its value at low frequency.

3.1.1.1 *Discussion—*This definition assumes the sensor channel response is low-pass, as in most materials testing. An illustration of bandwidth is shown in Fig. 1.

3.1.2 *Basic Data sample—*the sampled value of a sensor waveform taken at fixed time intervals. Each sample represents the actual sensor value at that instant of time.

3.1.2.1 *Discussion—*Fig. 2 shows examples of Basic Data samples.

3.1.3 *data rate* [T^1]*—*the data rate is $1/t_d$ Hertz where the time intervals between samples is t_d in seconds.

3.1.3.1 *Discussion—*The data rate is the number of data samples per second made available to the user, assuming the rate is constant.

3.1.4 *Derived Data—*any waveform parameter which is derived from one or several of the Basic Data samples.

3.1.4.1 *Discussion—*Fig. 2 illustrates examples of Derived Data.

3.1.5 *noise level—*the standard deviation of the data samples of noise in the transducer channel, expressed in the units appropriate to that channel.

3.1.6 *peak—*the point of maximum load in constant amplitude loading (see Terminology E 1823).

3.1.7 *phase difference* [$^\circ$]*—*the angle in degrees separating corresponding parts of two waveforms (such as peaks), where one complete cycle represents 360° .

3.1.7.1 *Discussion—*The phase difference of a cyclic waveform only has meaning in reference to a second cyclic waveform of the same frequency.

3.1.8 *sampling rate* [T^1]*—*the rate at which the analog-to-digital converter samples a waveform. This rate may not be visible to the user of the data acquisition system.

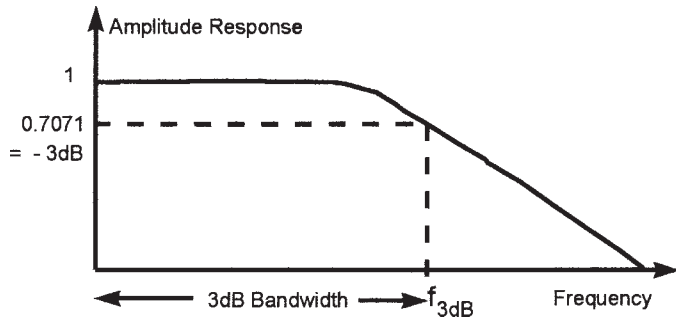

FIG. 1 3-dB Bandwidth of Sensor Channel

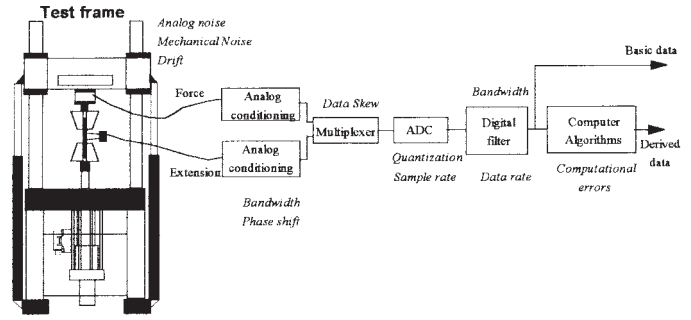

FIG. 3 Sources of Error in Data Acquisition Systems

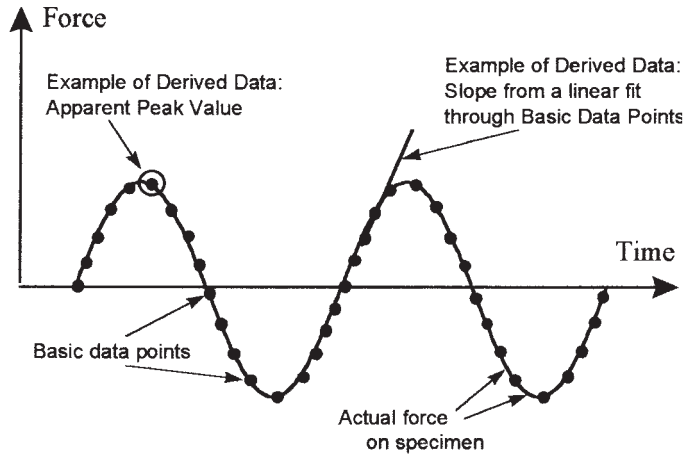

FIG. 2 Basic and Derived Data

3.1.8.1 Discussion—A distinction is made here between *sampling rate* and *data rate*, because in some data acquisition systems, the analog waveform may be sampled at a much higher rate than the rate at which data are made available to the user. (Such a technique is commonly known as *over-sampling*).

3.1.9 *word size*—the number of significant bits in a single data sample.

3.1.9.1 Discussion—The word size is one parameter which determines the system resolution. Usually it will be determined by the analog-digital converter used, and typically may be 12 or 16 bits. If the word size is w , then the smallest step change in the data that can be seen is 1 part in 2^w , that is the *quantization step* is $d = 2^{-w}$.

3.1.10 *valley*—The point of minimum load in constant amplitude loading (see Terminology E 1823).

4. Description of a Basic Data Acquisition System

4.1 In its most basic form, a mechanical testing system consists of a test frame with grips which attach to a test specimen, a method of applying forces to the specimen, and a number of transducers which measure the forces and displacements applied to the specimen (see Fig. 3). The output from these transducers may be in digital or analog form, but if they are analog, they are first amplified and filtered and then converted to digital form using analog-to-digital converters (ADCs). The resulting stream of digital data may be digitally filtered and manipulated to result in a stream of output Basic Data which is presented to the user in the form of a displayed or printed output, or as a data file in a computer. Various

algorithms may be applied to the Basic Data to derive parameters representing, for example, the peaks and valleys of the forces and displacements applied to the specimen, or the stresses and strains applied to the specimen and so forth. Such parameters are the Derived Data.

4.1.1 The whole measurement system may be divided into three sections for the purpose of verification: the mechanical test frame and its components, the electrical measurement system, and the computer processing of data. This guide is specifically concerned only with the electrical measurement system commencing at the output of the transducers. Before the mechanical system is investigated for dynamic errors by the methods given in Practice E 467, this guide can be used to ascertain that the electrical measurement system has adequate performance for the measurements required for Practice E 467. If the requirements of Practice E 467 for the mechanical system and the recommendations of this guide are met, then the user has confidence that the Basic Data produced by the testing system are adequate for processing by subsequent computer algorithms to produce further Derived Data.

4.1.2 At each stage of the flow of data in the electrical measurement system, errors can be introduced. These should be considered in the sequence in which these are dealt with in this guide. The sequence includes:

4.2 *Errors Due to Bandwidth Limitations in the Signal Conditioning*—Where there is analog signal conditioning prior to analog-to-digital conversion, there will usually be restrictions on the analog *bandwidth* in order to minimize noise and, in some cases, to eliminate products of demodulation. After digital conversion, additional digital filtering may be applied to reduce noise components. These bandwidth restrictions result in cyclic signals at higher frequencies having an apparent amplitude which is lower than the true value, and if the waveform is not sinusoidal, also having waveform distortion. The bandwidth restrictions also cause *phase shifts* which result in phase measurement errors when comparing phase in two channels with different bandwidths.

4.3 *Errors Due to Incorrect Data Rate*—Errors can result from an insufficient *data rate*, where the intervals between data samples are too large and intervening events are not recorded in the Basic Data. These result also in errors in the Derived Data, for example, when the peak value of a waveform is missed during sampling. *Data skew*, where the Basic Data are not acquired at the same instant in time, can produce similar errors to phase shifts between channels.

4.4 *Errors Due to Noise and Drift*—Noise added to the signal being measured causes measurement uncertainty. Short-term noise causes variability or random error, and includes *analog noise* at the transducer output due to electrical or mechanical pick up, and analog noise added in the amplifier, together with digital noise, or *quantization*, due to the finite digital word length of the ADC system.

4.4.1 Long-term effects, such as *drifts* in the transducer output or its analog signal conditioning due to temperature or aging effects, are indistinguishable from slow changes in the forces and displacements seen by the specimen, and cause a more systematic error.

4.4.2 Further details of these sources of error are given in Annex A1.

5. System Requirements

5.1 *How This Section is Organized*—This section gives the steps that must be taken to ensure the errors are controlled. There are several sources of error in the electrical system, and these may add both randomly and deterministically. To give reasonable assurance that these errors have a minor effect on overall accuracy of a system with 1 % accuracy, recommendations are given in this guide, which result in a 0.2 % error bound for each individual source of error. However, Annex A1 also shows how the error varies with each parameter, so that the user may choose to use larger or smaller error bounds with appropriate adjustments to bandwidth, data rate, and so forth.

5.1.1 In this section, which is intended to be used in the order written, a minimum value or a maximum value is recommended for each parameter. If the actual value of each parameter is known, then the system requirement is that in each case either:

$$\text{Maximum value} \geq \text{actual value}$$

or

$$\text{Minimum value} \leq \text{actual value.}$$

However, if the actual value is not known, then help is given as to how to determine it.

5.2 *Frequency and Waveshape*—The first step is to determine the highest cyclic frequency, f Hz, at which testing will occur, and the waveshape to be employed (for example, sinusoidal, triangular, square).

5.3 *Minimum Bandwidth*—If the waveform is sinusoidal or square, then the minimum bandwidth is $10f$ Hz to measure the peak value. If the waveform is triangular, then the minimum bandwidth is $100f$ Hz. For example, for a 10-Hz sinusoidal waveform, the minimum bandwidth is 100 Hz. For a discussion of minimum bandwidth, see A1.2.1 and A1.2.2.

5.4 *Actual Bandwidth*—The actual bandwidth must be equal to or greater than the minimum bandwidth. If this condition cannot be met, then the errors will increase as shown in A1.2.1 and A1.2.2. If the actual bandwidth is not known, then it can be ascertained using one of the suggested methods in A1.2.3, or otherwise.

5.5 *Minimum Data Rate*—For measurement of the peak value of sinusoidal or square waveforms, the minimum data rate is 50 points/cycle, or $50f$ points/s. For measurement of the peak value of triangular waveforms, the minimum data rate is 400 points/cycle, or $400f$ points/s. If the data acquisition system produces the peak value as an output, then the internal

Basic Data rate used should equal or exceed the appropriate minimum data rate (depending on waveform type). This should be verified even if the external rate at which samples are presented is less than this minimum value. For a discussion of data rate, see A1.3.1.

5.6 *Actual Data Rate*—The actual data rate must equal or exceed the minimum data rate. If the actual data rate is not known, then it must be ascertained using a method such as that in A1.3.2.

5.7 *Maximum Permitted Noise Level*—The noise level is the standard deviation of the noise in the transducer channel, expressed in the units appropriate to the channel. The maximum permitted noise level is 0.2 % of the expected peak value of the waveform being measured. For example, if the expected peak value in a load channel is 100 kN, then the standard deviation of the noise in that channel must not exceed 0.2 kN.

5.8 *Actual Noise Level*—The actual noise level must be equal to or less than the maximum permitted noise level. If the actual noise level is not known, then it must be ascertained using a method such as that in A1.4.6. Guidance on how to investigate sources of noise is given in A1.4.7.

5.8.1 If the actual noise level exceeds the maximum permitted noise level, it can usually be reduced by reducing bandwidth, but this will require beginning again at 5.3 to verify that the bandwidth reduction is permissible.

5.9 *Maximum Permissible Phase Difference and Maximum Permissible Data Skew*—These terms are discussed in A1.5.1 and A1.5.2. No value is recommended for the maximum permissible phase difference and data skew between channels, since this is very dependent on the testing application. If typical phase shifts between displacement and force due to the material under test are 10 to 20°, then an acceptable value for the maximum phase difference might be 1°. However, if typical phase shifts are 2 to 3°, the acceptable value for the maximum phase difference might be only 0.1°.

5.10 *Actual Phase Shift and Data Skew*—Methods for estimating the combined effect of phase shift and data skew in a data acquisition system are given in A1.5.3.

6. Report

6.1 The purpose of the report is to record that due consideration was given to essential performance parameters of the data acquisition system when performing a particular fatigue or fracture mechanics test. Since the report should ideally be an attachment to each set of such test results, it should be sufficient but succinct. The report should contain the following information, preferably in a tabular format.

6.2 *Measurement Equipment Description*—This should include the manufacturer's name, model number, and serial number for the test hardware used.

6.3 *Waveshape and Highest Frequency Used During the Test*

6.4 *Minimum Bandwidth, Actual Bandwidth, and a Note About its Source*—The source is a note describing how actual bandwidth was ascertained, for example, from a manufacturer's data sheet or by a measurement.

6.5 *Minimum Data Rate, Actual Data Rate, and a Note About Source*—The source is a note describing how actual data

rate was ascertained, for example, from a manufacturer’s datasheet or by a measurement.

6.6 *Maximum Permissible Noise Level, Actual Noise Level, and a Note About Source*—The source is a note describing how actual noise level was ascertained, for example, from a manufacturer’s datasheet or by a measurement.

6.7 *(Where Applicable) Maximum Permissible Phase Difference, Actual Phase Difference, and a Note About Source.*

6.8 *(Where Applicable) Maximum Permissible Data Skew, Actual Data Skew, and a Note About Source.*

7. Keywords

7.1 bandwidth; data acquisition; data rate; data skew; drift; fatigue; filter; fracture mechanics; noise; phase shift; quantization; sample rate; signal conditioning; step response

ANNEX

(Mandatory Information)

A1. SOURCES AND ESTIMATION OF ERRORS

A1.1 Method of Establishing Error Limits

A1.1.1 The approach used to develop the required performance levels for Section 5 has been to arrive at a value for bandwidth, data rate, and so forth, at which there is a high probability the error due to each cause will not exceed 0.2 %, and in most cases will be much less than this. The following sections provide explanations of how these values were derived. The explanations may be used to assess how rapidly errors might be expected to increase when the conditions set up in Section 5 cannot be met. A heuristic approach is necessary because there are very many variations of data acquisition systems, each of which would require a complex analysis to establish its actual errors. The approach taken here is conservative but should arrive at reasonably safe system requirements. Of necessity, the descriptions here are brief; more detailed discussion can be found in references.^{3,4,5}

A1.2 Bandwidth

A1.2.1 *Amplitude Errors in Sinusoidal Waveforms Due to Insufficient Bandwidth*—As shown in Fig. 1, the amplitude response of a filter with sinusoidal waveform inputs falls off at frequencies above the cutoff frequency and will cause increasing amplitude errors as frequency increases. The amplitude responses of typical Butterworth filters are shown in Fig. A1.1(a); the amplitude response rolls off above the cut-off frequency at a rate which depends on the number of pole-pairs in the filter. Thus if a sinusoidal waveform were applied to this filter, for example for a force transducer, its amplitude would be increasingly in error at frequencies approaching and above the cut-off frequency. Fig. A1.1(b) shows how these computed errors will increase with frequency. Bessel filters are also common in mechanical testing instrumentation, and the comparable curves are shown in Fig. A1.2. By considering both Fig. A1.1(b) and Fig. A1.2(b), it can be concluded that when

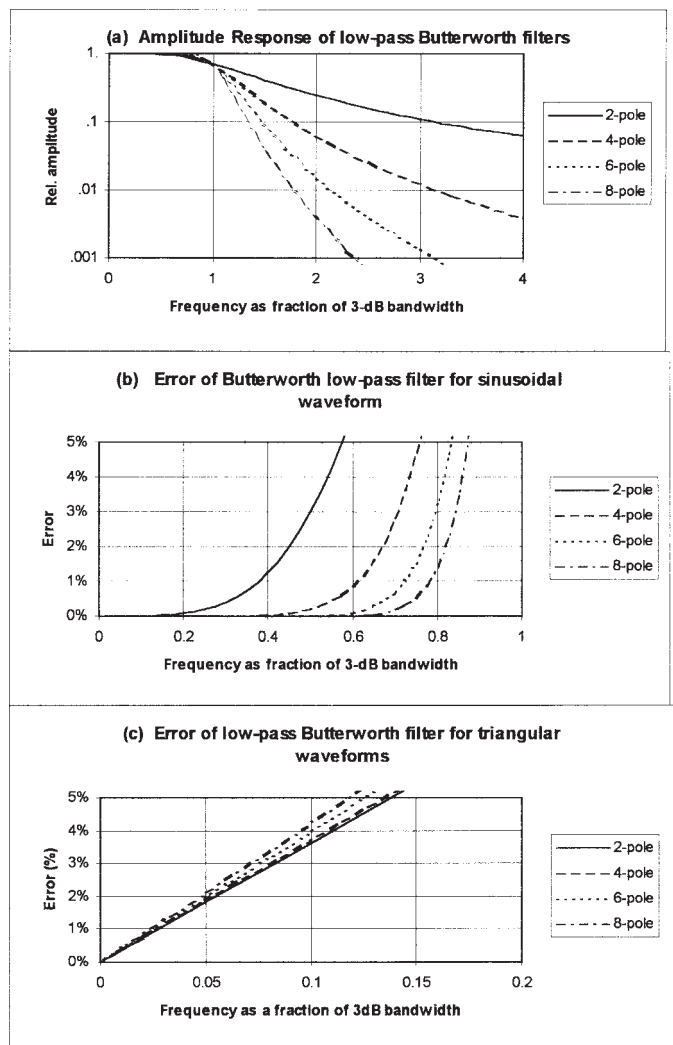

FIG. A1.1 Butterworth Filters

³ Stein, P. K., *The Unified Approach to the Engineering of Measurement Systems for Test and Evaluation - I - Basic Concepts*, Stein Engineering Services Inc., 6th ed., Phoenix, AZ, 1995.

⁴ Tovey, F. M., "Measurement Uncertainty Analysis of a Transfer Standard Force Calibration System," *Journal of Testing and Evaluation*, Vol. 22, No. 1, January 1994, pp. 70–80.

⁵ Wright, C. P., *Applied Measurement Engineering: How to Design Effective Mechanical Measurement Systems*, Prentice Hall, Englewood Cliffs, NJ, 1995.

the actual filter type employed by the test system is not actually known, then a conservative assumption would be that it is necessary that the frequency being measured is not larger than about 0.1 of the filter bandwidth for sinusoidal waveforms.

A1.2.1.1 If the filter type is indeed known from vendor-supplied data, choose the characteristic in Fig. A1.1(a) or Fig.

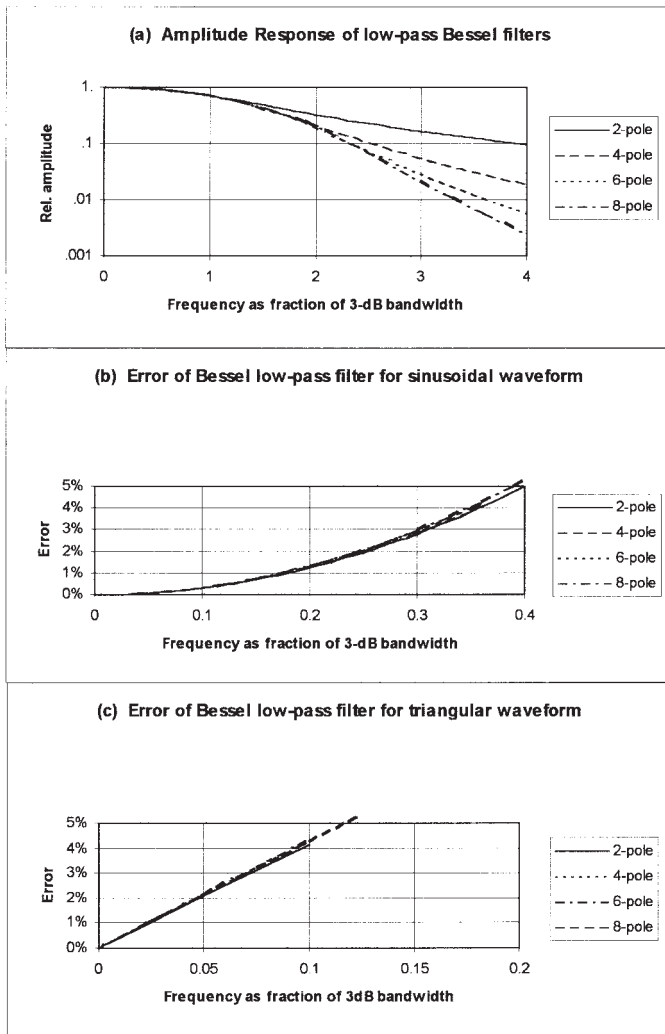

FIG. A1.2 Bessel Filters

A1.2(a) which is closest to the known filter characteristic, then use Fig. A1.1(b) or Fig. A1.2(b) to find the highest frequency which may be used within the permissible maximum error limit.

A1.2.2 *Amplitude Errors in Non-Sinusoidal Waveforms Due to Insufficient Bandwidth*—Errors in non-sinusoidal waveforms, such as triangular waveforms, can be more severe, because the amplitude of the harmonics begin to be affected when the fundamental frequency is still well below the cutoff frequency, and they are also affected by increasing phase shift. In the case of non-sinusoidal cyclic waveforms, these signals can be represented by a fundamental frequency and a number of multiples, or harmonics, of that frequency. These produce a *line spectrum*, as illustrated in Fig. A1.3 for a triangular waveform. The signal $x(t)$ can be represented exactly by a sum of sinusoids at the fundamental frequency f and its multiples, that is, $x(t) = \sum_{i=0}^{\infty} a_i * \cos(2\pi \cdot i \cdot f + \phi_i)$, where a_i is the amplitude of each harmonic and ϕ_i is the corresponding phase angle. As the order of the harmonic i increases, the amplitude generally decreases, and so only a small number of the harmonics have significance to $x(t)$. In Fig. A1.3, the third harmonic is 10 % of the amplitude of the fundamental, and the ninth harmonic is 1 % of the fundamental.

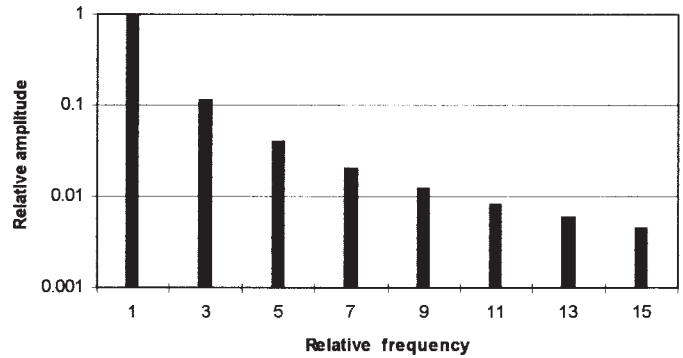

FIG. A1.3 Line Spectrum of a Triangular Waveform

A1.2.2.1 If the analog part of the signal conditioning were perfect, then this signal would be presented to the ADC to be sampled and digitized. In practice, however, the bandwidth of the analog channel is restricted, both to reduce noise and (in the case of conditioning systems with AC excitation) to remove the effects of demodulation. If we consider only the frequencies $i \cdot f$ of the signal, at each of these frequencies the filter will multiply the signal amplitude by b_i and add additional phase shift θ_i . At frequencies below the filter cutoff frequency, also called the bandwidth, $b_i \approx 1$ and $\theta_i \approx 0$. Above the cut-off frequency, b_i reduces towards zero and θ_i increases. If the signal has no significant amplitude in the harmonics a_i above the cutoff frequency, the filter will have no discernible effect on the signal. But, if indeed, there are harmonic components of significant amplitude above the filter cut-off frequency, then the signal will be distorted by the filter.

A1.2.2.2 A computation of these errors for Butterworth filters is shown in Fig. A1.1(c), and it can be seen that for errors below 0.5 %, the frequency would have to be less than 0.013 of the filter bandwidth. A similar conclusion can be reached for Bessel filters, as shown in Fig. A1.2(c). In practice, this will be very conservative, because the mechanical system will usually not be capable of generating a perfectly triangular waveform.

A1.2.2.3 For all other non-sinusoidal waveforms, the preceding limit for triangular waveforms will be a conservative estimate for the bandwidth needed, since a triangular waveform is the worst case likely to be encountered.

A1.2.3 *Procedure: How to Estimate Actual Bandwidth:*

A1.2.3.1 To estimate the actual bandwidth of a signal processing scheme, a measurement can be made of the step response of the system. This is the response of the measurement system to a step change in the input; the narrower the bandwidth, the slower the step response. Fig. A1.4 illustrates the response of a system to a step change in the parameter being measured by the transducer, and how this appears when digitized. The step responses of the different filters previously discussed are shown in Fig. A1.5, for a nominal bandwidth of 1 Hz. When the cut-off frequencies are raised, the time axes decrease proportionately. For example, if the bandwidth were 10 Hz, the time axis of the graph would span 0.4 s instead of 4 s.

A1.2.3.2 It can be shown that the bandwidth of any of these filters is simply related to the rise time between the 10 % and 90 % values of the step response, assuming the final amplitude is taken as 100 %. As can be seen from the table in Fig. A1.5,

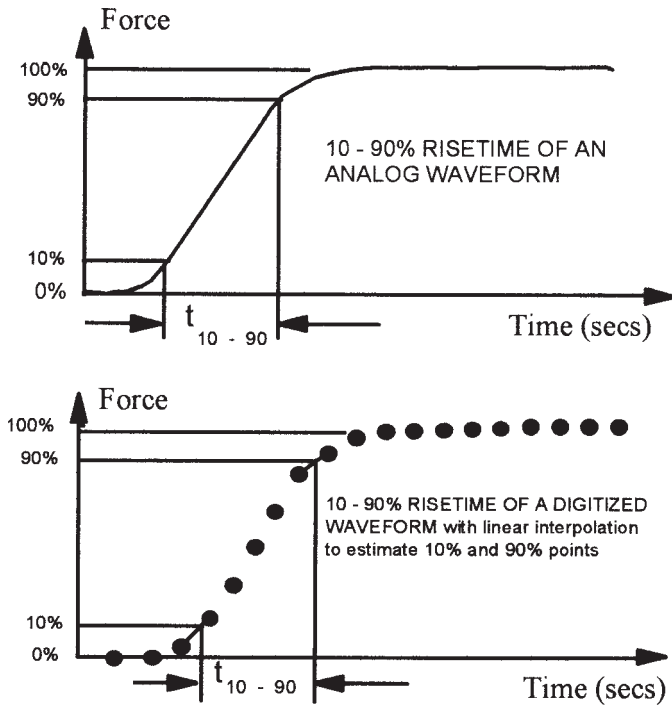

FIG. A1.4 Step Response

the rise time varies from 0.342 to 0.459 s for a 1-Hz bandwidth. Since Butterworth filters with large numbers of poles are less common (because of the increased ringing in the step response), it is common to use the following expression to estimate the bandwidth from the rise time.

$$\text{Bandwidth} = \frac{0.35}{t_{10-90}} \text{ Hz} \quad (\text{A1.1})$$

A1.2.3.3 To acquire the step response, it is necessary both to (1) create the step change in signal, and (2) have a method to record this.

A1.2.4 *Creating a Step Change Using a Shunt Calibration Facility*—The simplest measurement, which eliminates any mechanical problems, can be made if the system is provided with a shunt relay and resistor across the transducer to give a change in reading for verification purposes. This sudden change in transducer output is just as effective as breaking a specimen in producing a step input to the transducer conditioning, without the potential problem of mechanical ringing mentioned in A1.2.5. Before operating such a shunt relay, normal precautions, such as shutting off hydraulic power, should be taken to ensure the actuator does not move. Examples of data in this case are shown in Fig. A1.6.

A1.2.5 *Creating a Step Change By Breaking a Specimen*—If there is no shunt calibration relay available, then the next alternative is to produce a step change in force in the load string. One simple method to achieve this is to break a brittle specimen and record the sudden drop in load, for the fall-time is just as indicative of bandwidth as the rise time. For example, Fig. A1.7 shows the result of breaking a steel tape in a testing machine and capturing at a 5-kHz data rate the resulting sudden drop in force. In this machine, it was possible to vary the bandwidth to illustrate the changes in the step response, and three curves are shown, the first two showing

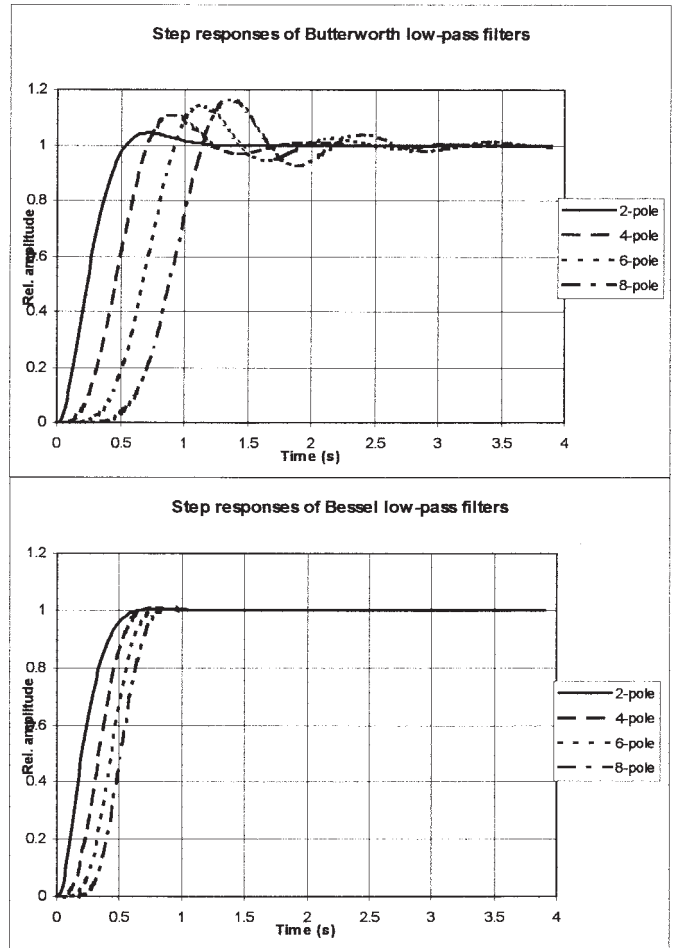

10-90% risetimes (secs) of step responses of 1Hz bandwidth filter

No. of poles	Butterworth	Bessel
2	0.342	0.342
4	0.387	0.349
6	0.426	0.349
8	0.459	0.346

FIG. A1.5 Computed Step Responses

data over 0.01 s, the last over 0.1 s. At 1-kHz bandwidth only about 2 data points cover the fall time of the step, but at lower bandwidths the resolution improves and more accurate estimates can be made. A problem at higher bandwidths that can be seen in this example is that the response is contaminated by ringing in the load string when the specimen breaks.

A1.2.6 *Recording the Step Response*—If the system produces an analog output, an analog recording device, such as an analog or a digital storage oscilloscope, may be used, and the step rise time may be measured on the oscilloscope screen or by down-loading the recorded response to a chart recorder. If the system is digital, it will be necessary to capture the response at a high enough data rate to ensure that several data samples are obtained during the rise time, as illustrated in the preceding examples. If there is an abrupt step and no data samples are obtained during the rise time, then all that can be concluded is that t_{10-90} must be equal to or less than the interval between data samples. Thus, using the time interval between samples will give a conservative minimum estimate of the bandwidth.

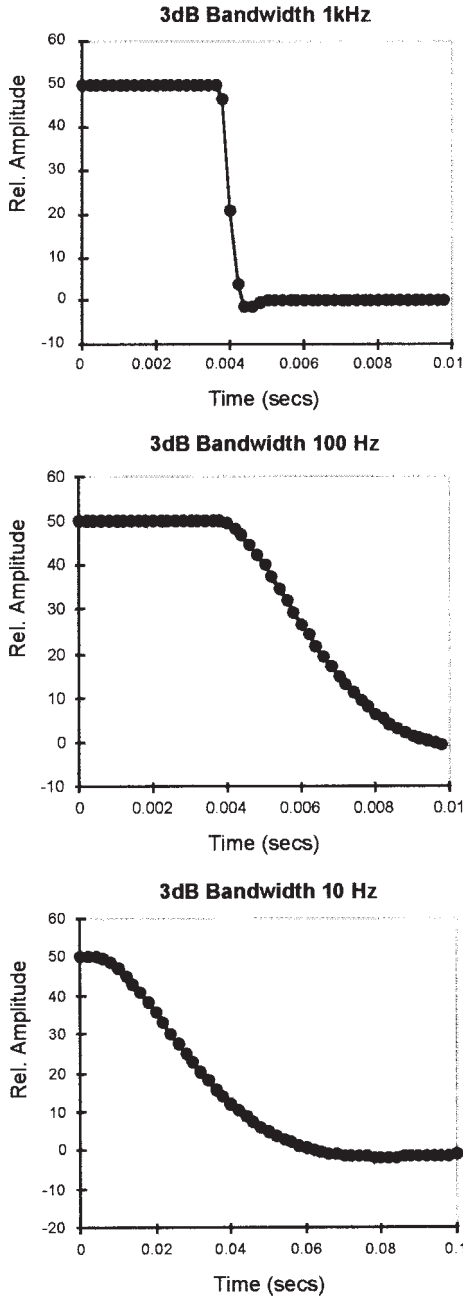

FIG. A1.6 Step Responses By Closing Calibration Relay

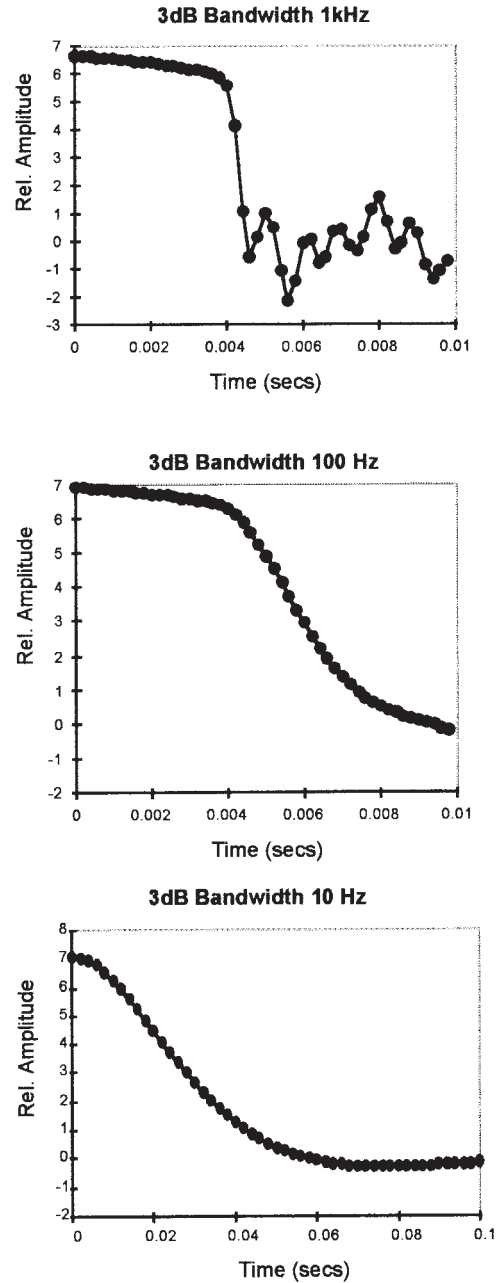

FIG. A1.7 Step Responses By Breaking a Brittle Specimen

A1.2.7 *Obtaining Bandwidth from Noise Spectra*—When it is not possible to create a step response by either of the two methods previously suggested, another method that is less accurate is to capture at a high data rate a string of samples of the sensor conditioner noise and apply these data to a Fourier transform routine to compute the noise spectrum. This noise will have been subjected to the same filtering as the signal, and hence its spectrum will indicate the filter roll-off frequency. Fig. A1.8 shows examples of noise captured on systems with bandwidths of 10 to 1000 Hz and Fourier-transformed. Interpreting such spectra visually to see the filter cutoff is somewhat subjective, but if the necessary computing capability is available, the method is relatively simple to apply.

A1.3 Data Rate

A1.3.1 *Amplitude Errors Caused By Insufficient Data Rate*—Errors in deriving the amplitude of a waveform may result when the method of estimating amplitude is simply to acquire the largest data value which occurs during one cycle. For a sine wave, it can be shown that for an error less than ϵ % in the estimate of its amplitude from a simple peak detector, it is necessary that the waveform contain at least $22.2 / \sqrt{\epsilon}$ samples/cycle, as shown in Fig. A1.9(a). Using this expression, for not greater than 0.2 % error it will require at least 49.6 samples/cycle.

A1.3.1.1 For a triangular waveform, which is probably the worst case encountered in materials testing, for an error less than ϵ % in the estimate of its amplitude, it will be necessary,

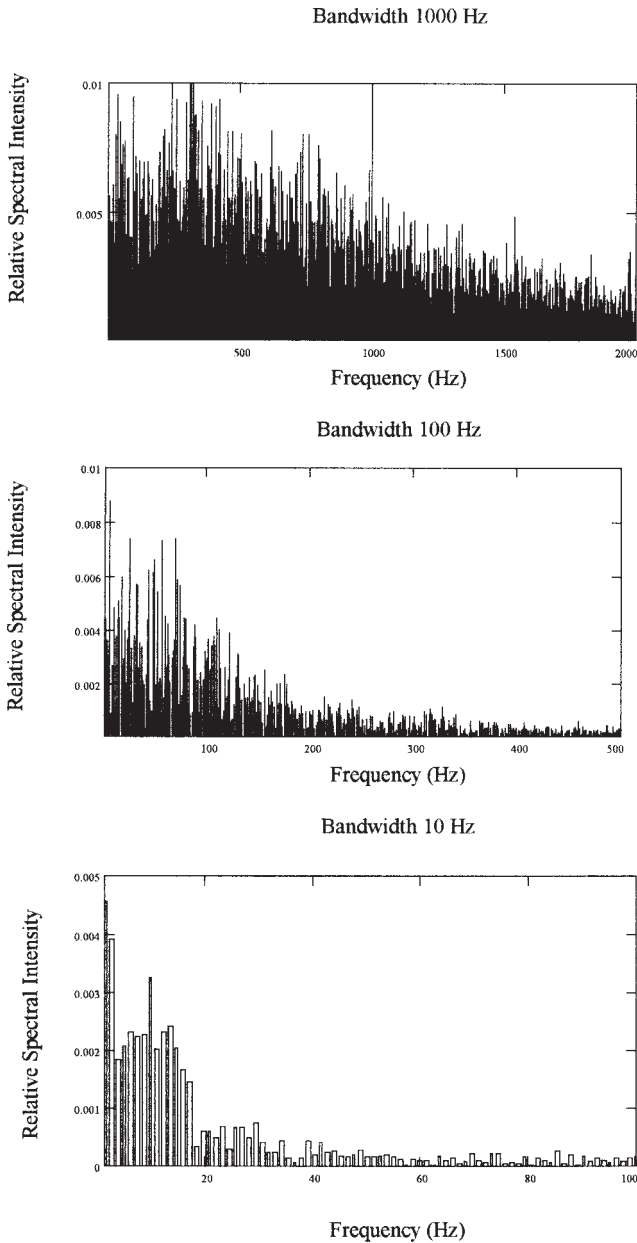
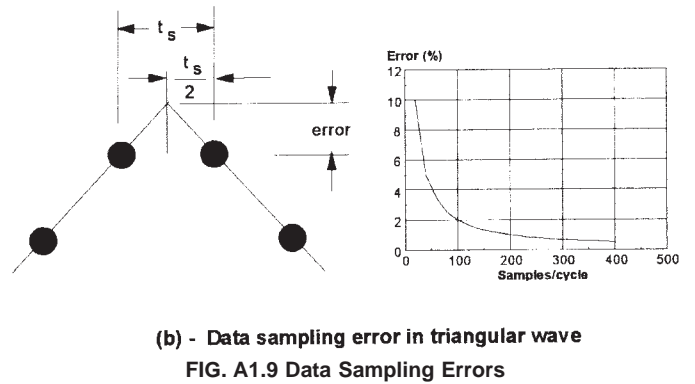
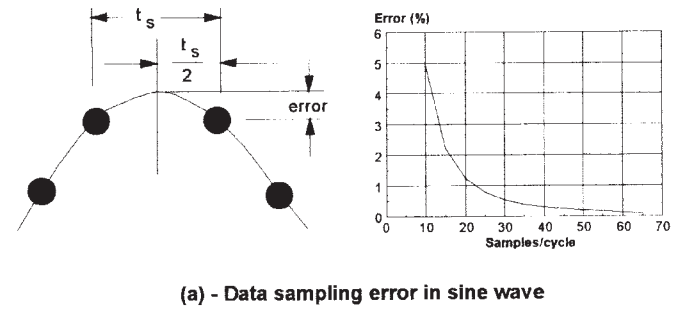

FIG. A1.8 Noise Spectra to Determine System Bandwidth

in theory, that the waveform contain at least 200ϵ samples/cycle, as shown in Fig. A1.9(b). For not more than 0.2 % error, it would thus require at least 1000 samples/cycle. This is an extreme requirement, however, since (1) the mechanical system is usually incapable of reproducing a perfect triangular waveform, and (2) unless the data rate is an exact multiple of the frequency f of the waveform, the estimated peak value will fluctuate between the exactly correct value and the value given previously, which is the worst case. In practical terms, 400 samples/cycle should be considered adequate.

NOTE A1.1—In principle, if the waveform is known to be sinusoidal, only a few samples of the sine wave would be required to describe it completely. Any intermediate values and, in particular, the maximum and minimum values to produce the waveform amplitude, could be obtained by interpolation. In practice, however, the waveform is instead usually grossly over-sampled at rates well above the theoretical Nyquist rate to



give many samples per cycle, and the maximum and minimum values obtained from this.

A1.3.2 Procedure: How to Estimate Actual Data Rate—The actual data rate may be estimated by cycling the transducer at a frequency which is known to be much less than the data rate, and collecting and counting the number of samples/cycle. For example, if the data rate were 1000 Hz, and the test system was run at 10 Hz collecting data samples, examination of the data would show that there were exactly 100 samples in each cycle.

A1.4 Noise

A1.4.1 Definition of Noise—For the purposes of this guide, noise is defined as any additive spurious signal which contributes to uncertainty in the Basic Data, and it may be random or periodic. It is relatively easy to observe the effect of additive noise; if the force or extension is known to be static, then fluctuations in the Basic Data are caused by additive noise. An estimate of the magnitude of this noise may be made by capturing a stream of a few hundred successive data values into a spreadsheet and computing the mean \bar{x} and standard deviation s from

$$\bar{x} = \frac{\sum_{i=1}^N x_i}{N} \text{ and} \tag{A1.2}$$

$$s = \sqrt{\frac{\sum_{i=1}^N (x_i - \bar{x})^2}{N-1}} \tag{A1.3}$$

A1.4.1.1 If the noise were random, almost all of the scattered data values would lie within $\pm 3s$ of the mean, and measurement of s gives a simple quantitative measurement of the effect of additive noise on the data.

A1.4.1.2 There are many potential sources of noise in the testing system, and the following is a list of some of these.

A1.4.2 *Electrical Noise:*

A1.4.2.1 *Thermal Noise*—The electrical noise introduced at the input to the amplifier itself is an inherent property of the amplifier. In a properly designed system, all of the significant noise should occur at this input stage, and the amplification should ensure that any other sources of electrical noise after this preamplifier are swamped by the signal. The electrical noise is usually spread over a much higher band of frequencies than the bandwidth of the mechanical responses being measured, and the amplitude of the noise which is added to the signal is generally proportional to the square root of the bandwidth of the noise. Therefore, the noise can be reduced by reducing its bandwidth, by filtering in analog and digital sections of the signal conditioner. However, if the bandwidth is reduced too much, the reduction in the noise amplitude will be at the expense of waveform fidelity of the transducer signals. It is thus important for the user to be aware of the bandwidth of these transducer signals.

A1.4.2.2 *Electrical Power Supply Ripple*—This is noise at the power line frequency (50 Hz or 60 Hz) or multiples of this frequency, typically introduced by poor electrical grounding or poor filtering of the DC power supply in the electronics. The easiest method to identify if this is a source of the fluctuations in the Basic Data is to examine the spectral characteristics of the noise with a spectrum analyzer, or by taking the Fourier transform of a record of the data. The electrical power supply noise has a simple line spectrum at the power line frequency (such as 50 or 60 Hz) and its harmonics, but it may be of sufficiently low amplitude to be masked by other sources of noise when examined simply as a time series on a data plotter. Examination of its *spectrum* can reveal such line spectra.

A1.4.2.3 *Computer Digital Noise*—When sensitive transducer electronics are installed in the same package as a computer, there is a tendency to pick up radiated noise from the digital signals propagating from the computer boards. These can take the form of very high frequency spikes, but when sampled at relatively low rates by the ADC these may be indistinguishable from thermal noise because of aliasing. Verifying, if this is indeed a source of noise, is difficult because turning off the computer usually also turns off the power supply to the conditioning electronics. If board extenders are available, it may be possible to change the physical configuration of the boards and note whether this produces a change in noise standard deviation s .

A1.4.2.4 *RF Induction Heater Noise*—The RF induction heaters produce high frequency high magnetic fields which can couple into transducer wiring. Such spurious signals can be identified as line spectra, even though they may be heavily aliased by the low sampling rate of the ADC.

A1.4.2.5 *Furnaces for Heating Specimens*—These operate at normal power line frequencies, but the current spikes can be very large and the resulting magnetic fields couple into sensitive elements like strain gage bridges. Again, the noise can be identified by its line spectrum, or by simply turning off the furnace and checking if there is a change in noise standard deviation s .

A1.4.2.6 *Radiated Noise*—Electromagnetic radiation can couple into sensitive signal lines, such as those connected to strain gages, and the high frequency spurious signals can be rectified by the amplifier and appear as a low frequency offset. The simplest method to detect this source of noise is to turn off the source of radiation, and the most effective preventative measure is to shield all the wiring carefully, and to use radio-frequency filtering devices where the wiring enters the electronics package.

A1.4.3 *Mechanical Noise*—Mechanical noise is noise caused by mechanical vibrations in the test frame and grips due to uncontrolled disturbances. These might be vibrations transmitted into the frame from the floor on which it stands, or into a hydraulic actuator from the hydraulic power supply, or hydraulic flow noise in the servo-valve. All of these result in motion of the specimen relative to the test frame which is picked up in the load cell and extensometer and appears as added noise at the transducer output. Some of the noise associated with rotating mechanical components like the hydraulic pump has narrow spectral characteristics, allowing its source to be identified with a spectrum analyzer, but other noise like servo-valve flow noise has a wide-band characteristic which may be indistinguishable from thermal noise, but easily identified by turning off the power supply and measuring any change in noise standard deviation s .

NOTE A1.2—In addition to data errors, such mechanical noise does indeed imply small additional forces are being applied to the fatigue specimen under test. The user should consider whether they have sufficient amplitude to affect fatigue life of the specimen.

A1.4.4 *Quantization Noise*—Quantization noise is the other primary source of noise in a digital data acquisition system. Because it has a fixed data word size, the ADC has only a finite number of values it can use to represent an input analog signal. A 12-bit ADC has only 4096 discrete values, while a 16-bit ADC has 65 536 values. If the input analog signal were perfectly free from noise, the ADC output would jump from one discrete value to another (see Fig. A1.10). It can be shown

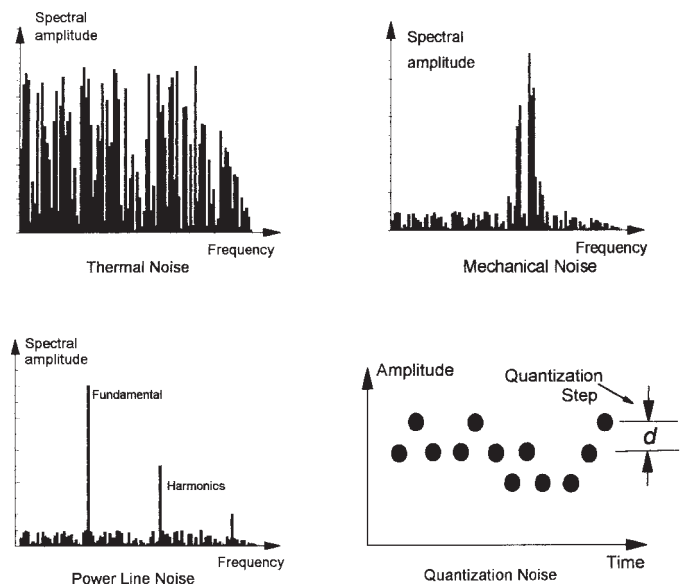

FIG. A1.10 Examples of Different Noise Types

that this uncertainty in the precise value of the output is equivalent to a noise standard deviation from quantization of $S_q = d / \sqrt{12}$, where d is the size of the quantization step (for example, $d = 2^{-16}$ of total input span for a 16-bit ADC). Ranging of the analog signal can be used if necessary to ensure that quantization noise is minimized relative to the noise inevitably present from the input amplifier.

A1.4.4.1 If the system noise level is a limitation on the measurements to be made, it should be determined if quantization noise is a significant component of the total noise. To do this, capture several hundred samples of the output of the data acquisition system and compute s as mentioned previously. Also, by forming a histogram of the data values or otherwise, determine the inherent quantization step size d of the system ADC, and verify that $s \gg s_q$. If not, then it will be necessary to increase the signal level before the ADC, either by using a more sensitive transducer or by using a preamplifier.

A1.4.5 Effect of Noise on System Resolution and Calibration:

A1.4.5.1 Noise adds additional uncertainty to obtaining the correct value for a measured parameter. Without noise, the uncertainty would be determined by the calibration errors of the transducer and the conditioning electronics. With noise, but without any such calibration errors, the distribution of values around the correct value would be determined by the overall noise standard deviation s measured under static conditions. In practice, both sources of error are always present, and a well-designed system will try to maintain a balance so that the noise errors are always somewhat less than the calibration errors. Each successive data sample has an uncertainty due to noise which adds to the uncertainty due to calibration errors.

A1.4.5.2 The magnitude of the effect of noise will depend on the level of sophistication of the algorithms employed. For example, with the *a priori* knowledge of the operating frequency in cyclic testing, averaging at the corresponding points on successive cycles can be used to reduce the uncertainty of the values.

A1.4.5.3 Apart from issues of data inaccuracy, another advantage of reducing the noise standard deviation is that the closer the spread in readings around a true transducer value, the easier it is for statistical techniques to be used to notice trends in parameter values.

A1.4.5.4 The maximum permissible noise level, which is the acceptable level of noise in the data, depends on which kind of data are going to be derived from the basic data containing the noise. For example, an amplitude measurement which is made by acquiring the largest data value occurring during one cycle will be more susceptible to noise than the mean value of the waveform calculated during the same cycle, because the former depends on only one sample, whereas the latter is from the average of many samples. The most conservative value for the maximum permissible noise level will be to assume no data smoothing by subsequent algorithms, and in this case the maximum allowable standard deviation of the noise is 0.2 % of the peak value of the waveform being measured, which ensures that a single measurement of the peak will be within 0.5 % of the correct value with 99 % confidence.

A1.4.6 Procedure: How to Measure Actual Noise Level—To estimate the actual noise level, configure the system as nearly as possible in the same format as when actual testing is taking place, but with the transducer inputs nominally constant. For example, install a specimen in the testing machine with an extensometer if required, turn on the hydraulic power supply, and hold the actuator at a constant position. Capture a consecutive stream of at least 100 data points at the same data rate as is intended for the actual test, for each transducer channel. Fig. A1.11 shows an example of such noise samples captured on a typical testing machine at a rate of 5000 samples/s. Compute the standard deviation of these data using the formula shown; this is the actual noise level.

A1.4.7 Procedure: How to Distinguish Sources of Noise:

A1.4.7.1 Much can be learned about the sources of contaminating noise by use of spectral analysis, either by using a commercial spectrum analyzer, or by capturing a stream of noise data from the testing machine and using a Fourier analysis program. Examples of spectra and waveforms for different sources of noise are shown in Fig. A1.10.

A1.4.7.2 To give a more detailed example, Fig. A1.12 shows noise data from a testing machine and the noise spectrum. It illustrates how more revealing it can be to use spectral analysis. A portion of the 4096 point data stream lasting 0.1s is shown, taken at 5 kHz, and its spectrum shown alongside. A very small amplitude sine wave at 60 Hz was then added to the data, and its effects are not visible when the waveform is examined. However, the spectrum of this modified noise data now clearly shows the 60-Hz component. In this way, sources of noise caused by electrical contamination of the required signals, or by mechanical vibration of the frame, caused for example by a nearby hydraulic power supply, will not be visible in the noise waveform but will be seen in the associated spectrum.

A1.5 Phase Difference and Data Skew

A1.5.1 Phase Difference, Effect on Stress/Strain Measurements—Amplitude errors of a waveform due to restricted bandwidth have been mentioned in A1.2. In addition, restrictions on bandwidth cause increasing phase shifts in the conditioner. For analog signals, it is often important to understand the phase *difference* between two signal channels, occurring because the two signals pass through filters whose phase characteristics are different. For example, Fig. A1.13 shows a plot of force versus strain in a test at 1 Hz, for the cases where

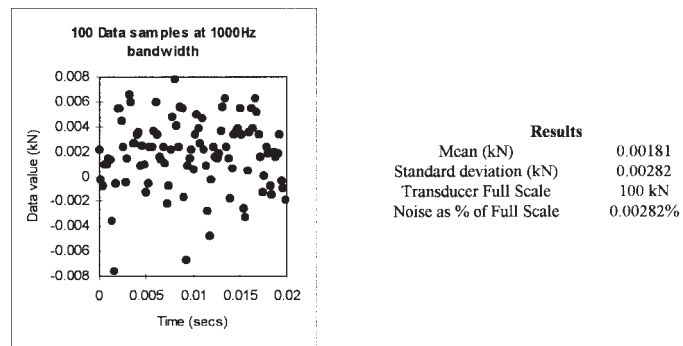

FIG. A1.11 Measuring System Noise Level

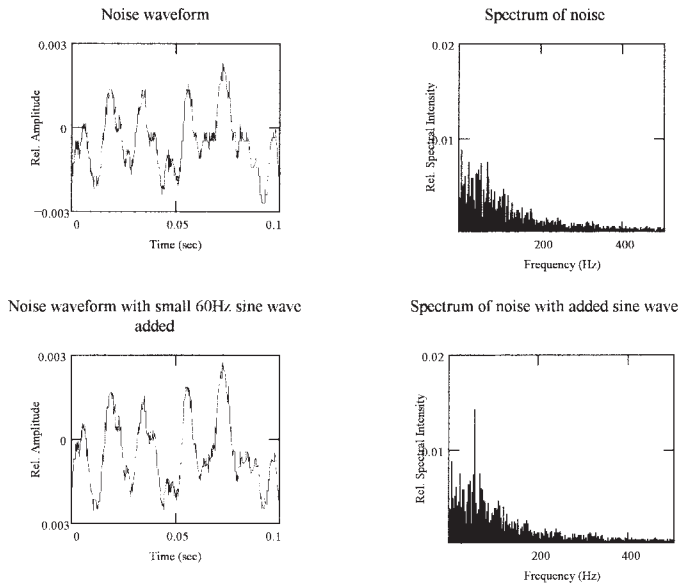

FIG. A1.12 The Noise Spectrum Can Be More Revealing Than the Waveform

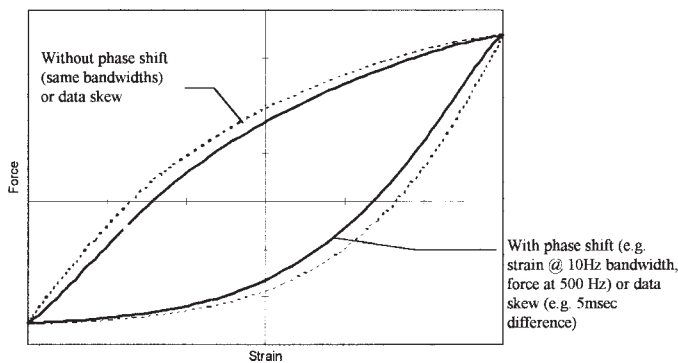

FIG. A1.13 Effect on Hysteresis Loop of Different Bandwidths or of Data Skew

(1) both the force and strain signals have passed through the same bandwidth filter, and (2) where the load filter was 10-Hz bandwidth and the strain filter was 500 Hz. The difference in the latter case is because the filters have different phase shifts at 1 Hz. The problem is avoided by ensuring that both channels have the same bandwidth characteristics.

A1.5.2 Data Skew:

A1.5.2.1 Data skew refers to the situation where samples of two transducer signals are not taken at precisely the same instant in time, and hence for example, the strain value does not exactly correspond with the stress value. This usually occurs when a single ADC is used and multiplexed without an analog sample-and-hold circuit to hold both analog values simultaneously. The result of data skew is exactly the same as that of a difference in phase shifts between two channels, and Fig. A1.13 also can illustrate this.

A1.5.2.2 In modern data acquisition systems, the data skew is normally held to less than 10 μ s, or eliminated altogether by

using multiple ADCs for each transducer channel. In measuring the difference in apparent phase between two sine waves that have been sampled digitally, the effects of a phase shift in the analog part of the signal channel and data skew at the time it is converted into digitized form are indistinguishable. So the combined errors due to both may be measured at the same time.

A1.5.3 Procedure: How to Measure Phase Difference and Data Skew Between Transducer Channels:

A1.5.3.1 To measure the errors between two transducer channels caused by phase shift or data skew, it is necessary to apply stimuli to both channels that are known to be mechanically inphase. Then any resulting phase shift is a measure of the residual differences between the two inputs in the sensor conditioning. An example of such a known in-phase condition would be by making measurements of force and strain on a specimen at stresses at 60 % or less of its elastic limit. By plotting the data from one channel against the data from another, as shown in Fig. A1.14, any phase shift will result in the graph being other than a straight line. The phase shift may be estimated by measuring the ratio of the width of the hysteresis loop b at its center to the overall span of the loop on the same axis a . The phase angle difference ϕ is given from $\phi = \sin^{-1}(b/a)$.

A1.5.3.2 However, if the phase difference is less than a few degrees, the preceding measurement will be difficult to make, and a more accurate estimate of the phase difference which is more robust when there is noise in the data may be made by acquiring an integral number of data points over one cycle for both sinusoidal waveforms. For example, at 10 Hz acquire exactly 50 data points over one cycle by setting the data rate at 500 Hz. Ensure that the noise standard deviation is less than 0.5 % of the waveform amplitude in each channel, as described in A1.4.6.

A1.5.3.3 Suppose there are N data points taken per cycle, and the two sets of data are a_n and b_n respectively, where $n=0$ to $N-1$. The phase shift ϕ in degrees between the two

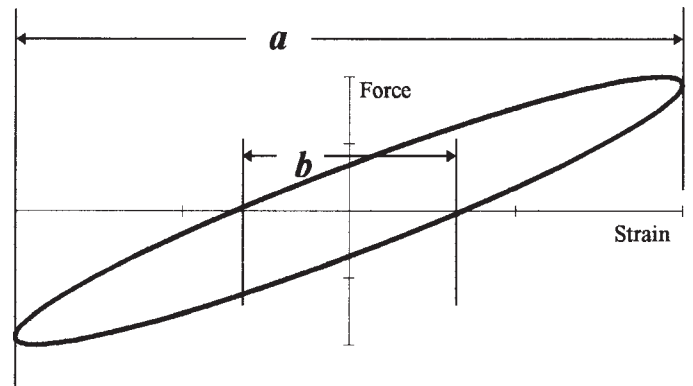

FIG. A1.14 Obtaining Phase Difference from a Plot of a Known In-Phase Condition

waveforms is given by the following expression, which may be computed using any common spreadsheet or calculator program:

$$\phi = \frac{180}{\pi} \cdot \left\{ \tan^{-1} \left[\frac{\sum_{n=0}^{N-1} \sin \left(2 \cdot \pi \cdot \frac{n}{N} \right) \cdot a_n}{\sum_{n=0}^{N-1} \cos \left(2 \cdot \pi \cdot \frac{n}{N} \right) \cdot a_n} \right] - \tan^{-1} \left[\frac{\sum_{n=0}^{N-1} \sin \left(2 \cdot \pi \cdot \frac{n}{N} \right) \cdot b_n}{\sum_{n=0}^{N-1} \cos \left(2 \cdot \pi \cdot \frac{n}{N} \right) \cdot b_n} \right] \right\} \quad (\text{A1.4})$$

A1.6 Long-Term Instability

A1.6.1 Drift with Time and Temperature:

A1.6.1.1 The output of a transducer channel may vary slowly over time, even with no true change in the parameter value it is measuring. This is known as drift. Temperature is the most common problem, caused by sensitivity of the transducer itself or its conditioning electronics to even very small changes in temperature. The designer of a transducer such as a load cell or an extensometer takes great care to minimize sensitivity to temperature by use of compensating resistance elements, which see the same ambient temperature as the strain gages but not the strains caused by the applied deflection. During manufacture, such transducers are usually individually com-

pensated after cycling the device through a temperature chamber, and so the temperature coefficient is a known and available quantity. In laboratory use, it is necessary to keep ambient temperature changes minimized to ensure that changes in transducer output are small compared with the parameters being measured. If this cannot be guaranteed, one solution may be to use a more sensitive transducer. There are temperature effects that may give errors that exceed those expected from the steady state temperature coefficient. A sudden change in laboratory ambient temperature can cause a temperature differential across the transducer, which means that its built-in temperature compensation is less effective, and until the transducer reaches temperature equilibrium again there will be a larger swing in output than would be predicted from the temperature coefficient.

A1.6.1.2 The drift errors are derived almost entirely from deficiencies in the transducer design; modern electronics have almost eliminated drift in the electronics as a cause of long-term instability by the use of digital technology. No recommended procedure is therefore given here for assessment of drift errors in the analog conditioning and the user is encouraged to heed the transducer manufacturer's specification for temperature sensitivity and where necessary, take steps to prevent large temperature fluctuations in the transducer.

ASTM International takes no position respecting the validity of any patent rights asserted in connection with any item mentioned in this standard. Users of this standard are expressly advised that determination of the validity of any such patent rights, and the risk of infringement of such rights, are entirely their own responsibility.

This standard is subject to revision at any time by the responsible technical committee and must be reviewed every five years and if not revised, either reapproved or withdrawn. Your comments are invited either for revision of this standard or for additional standards and should be addressed to ASTM International Headquarters. Your comments will receive careful consideration at a meeting of the responsible technical committee, which you may attend. If you feel that your comments have not received a fair hearing you should make your views known to the ASTM Committee on Standards, at the address shown below.

This standard is copyrighted by ASTM International, 100 Barr Harbor Drive, PO Box C700, West Conshohocken, PA 19428-2959, United States. Individual reprints (single or multiple copies) of this standard may be obtained by contacting ASTM at the above address or at 610-832-9585 (phone), 610-832-9555 (fax), or service@astm.org (e-mail); or through the ASTM website (www.astm.org).